



**5 3 3 1**

**2-Draht Universal-  
Messumformer**

Nr. 5331V114-DE  
Ab Seriennr. 141365001



**IECEX**



**CCOE**

**ATEX**



**ERC** **CE**

## Revision Notes

The following list provides notes concerning revisions of this document.

<b>Rev. ID</b>	<b>Date</b>	<b>Notes</b>
113	13/45	IECEX and INMETRO approvals added
114	15/10	PESO/CCOE approval added GOST approval replaced with EAC approval

# 2-DRAHT UNIVERSALMESSUMFORMER

## 5331

### Inhaltsverzeichnis

Verwendung.....	2
Technische Merkmale.....	2
Montage / Installation .....	2
Anwendungen.....	3
Bestellangaben: 5331 .....	4
Elektrische Daten .....	4
Anschlüsse .....	8
Blockdiagramm.....	9
Programmierung.....	10
Abmessungen .....	11
Montage von Fühlerleitungen.....	11
Appendix .....	12
ATEX Installation Drawing - 5331A .....	13
ATEX Installation Drawing - 5331D .....	14
IECEX Installation Drawing - 5331A.....	16
IECEX Installation Drawing - 5331D.....	17
FM Installation Drawing - 5331D.....	19
CSA Installation Drawing - 5331D.....	21
INMETRO Instruções de Segurança - 5331A.....	23
INMETRO Instruções de Segurança - 5331D.....	24

# 2-DRAHT UNIVERSALMESSUMFORMER 5331

- *Eingang für WTH, TE,  $\Omega$  oder mV*
- *Extreme Messgenauigkeit*
- *1,5 kVAC mit galvanische Trennung*
- *Programmierbare Sensorfehlanzeige*
- *Für Einbau in Anschlusskopf DIN Form B*

## **Verwendung**

- Linearisierte Temperaturmessung mit Pt100...Pt1000, Ni100...Ni1000 oder Thermoelementsensoren.
- Umwandlung von linearer Widerstandsänderung in ein analoges Standard-Stromsignal, z.B. von Ventilen oder Niveau-Messwertgeber.
- Verstärkung von bipolaren mV-Signalen zu einem Standard 4...20 mA Stromsignal.

## **Technische Merkmale**

- PR5331 kann vom Benutzer innerhalb von wenigen Sekunden zur Messung in allen genormten Temperaturbereiche programmiert werden.
- Der WTH- und Widerstandseingang haben Leitungskompensation bei 2-, 3- oder 4-Leiter-Anschluss.
- Die gespeicherten Daten werden laufend kontrolliert.

## **Montage / Installation**

- Für DIN Form B Sensorkopf Montage. Im sicheren Bereich kann der 5331 auf einer DIN-Schiene mittels der PR-Armatur Typ 8421 montiert werden.

# ANWENDUNGEN

WTH in 4...20 mA

2-Draht-Installation  
im Kontrollraum

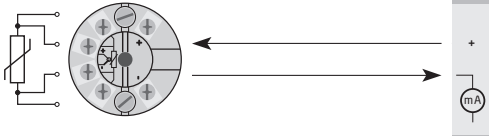

TE in 4...20 mA

2-Draht-Installation  
im Kontrollraum

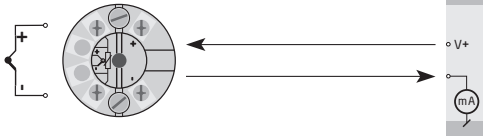

Widerstand  
in 4...20 mA

2-Draht-Installation  
im Kontrollraum

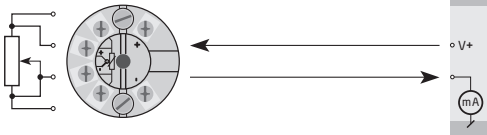

mV in 4...20 mA

2-Draht-Installation  
im Kontrollraum

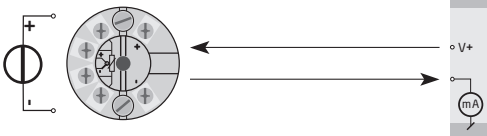

## Bestellangaben: 5331

Typ	Version	Umgebungs- temperatur	Galvanische Trennung
5331	Standard : A CSA, FM, ATEX, IECEX & INMETRO : D	-40°C...+85°C : 3	1500 VAC : B

## Elektrische Daten

### Spezifikationsbereich:

-40°C bis +85°C

### Allgemeine Daten:

Versorgungsspannung, DC

Standard..... 7,2...35 V

CSA, FM, ATEX, IECEX & INMETRO..... 7,2...30 VDC

Eigenverbrauch..... 25 mW...0,8 W

Spannungsabfall ..... 7,2 VDC

Isolationsspannung, Test / Betrieb ..... 1,5 kVAC / 50 VAC

Aufwärmzeit ..... 5 Min.

Kommunikationsschnittstelle ..... Loop Link

Signal- / Rauschverhältnis..... Min. 60 dB

Ansprechzeit (programmierbar) ..... 1...60 s

EEProm Fehlerkontrolle ..... < 3,5 s

Signaldynamik, Eingang..... 20 bit

Signaldynamik, Ausgang..... 16 bit

Kalibrierungstemperatur..... 20...28 °C

Genauigkeit, höherer Wert von allgemeinen und Grundwerten:

Allgemeine Werte		
Eingangsart	Absolute Genauigkeit	Temperatur- koeffizient
Alle	≤ ±0,05% d. Messsp.	≤ ±0,01% d. Messsp./°C

Grundwerte		
Eingangsart	Grund-Genauigkeit	Temperaturkoeffizient
WTH	$\leq \pm 0,2^\circ\text{C}$	$\leq \pm 0,01^\circ\text{C}/^\circ\text{C}$
Lin. R	$\leq \pm 0,1 \Omega$	$\leq \pm 10 \text{ m}\Omega / ^\circ\text{C}$
Volt	$\leq \pm 10 \mu\text{V}$	$\leq \pm 1 \mu\text{V} / ^\circ\text{C}$
TE-Typ: E, J, K, L, N, T, U	$\leq \pm 1^\circ\text{C}$	$\leq \pm 0,05^\circ\text{C} / ^\circ\text{C}$
TE-Typ: B, R, S, W3, W5, LR	$\leq \pm 2^\circ\text{C}$	$\leq \pm 0,2^\circ\text{C} / ^\circ\text{C}$

EMV-Immunitätswirkung.....	< $\pm 0,5\%$ d. Messsp.
Erweiterte EMV-Immunität: NAMUR NE 21, A Kriterium, Burst.....	< $\pm 1\%$ d. Messsp.

#### Einfluss von Änderung der

Versorgungsspannung.....	< 0,005% d. Messsp. / VDC
Vibration.....	IEC 60068-2-6 : 2007
2...25 Hz.....	$\pm 1,6 \text{ mm}$
25...100 Hz.....	$\pm 4 \text{ g}$
Max. Leitungsquerschnitt .....	1 x 1,5 mm <sup>2</sup> Litzendraht
Klemmschraubenanzugsmoment.....	0,4 Nm
Luftfeuchtigkeit .....	< 95% RF (nicht kond.)
Maß.....	$\emptyset 44 \times 20,2 \text{ mm}$
Schutzart (Gehäuse / Anschluss).....	IP68 / IP00
Gewicht.....	50 g

#### Elektrische Daten, Eingang:

##### WTH- und Linearer Widerstandseingang:

WTH-Typ	Min. Wert	Max. Wert	Min. Spanne	Norm
Pt100	-200°C	+850°C	25°C	IEC 60751 DIN 43760 -----
Ni100	-60°C	+250°C	25°C	
Lin. R	0 $\Omega$	5000 $\Omega$	30 $\Omega$	

Max. Nullpunktverschiebung (Offset).....	50% des gewählten Maximalwertes
Leitungswiderstand pro Leiter (max.).....	5 $\Omega$
Sensorstrom.....	Nom. 0,2 mA
Wirkung des Fühlerkabelwiderstandes (3- / 4-Leiter).....	< 0,002 $\Omega / \Omega$
Fühlerfehlererkennung.....	ja

**TE-Eingang:**

Typ	Min. Temperatur	Max. Temperatur	Min. Spanne	Norm
B	+400°C	+1820°C	100°C	IEC584
E	-100°C	+1000°C	50°C	IEC584
J	-100°C	+1200°C	50°C	IEC584
K	-180°C	+1372°C	50°C	IEC584
L	-100°C	+900°C	50°C	DIN 43710
N	-180°C	+1300°C	50°C	IEC584
R	-50°C	+1760°C	100°C	IEC584
S	-50°C	+1760°C	100°C	IEC584
T	-200°C	+400°C	50°C	IEC584
U	-200°C	+600°C	50°C	DIN 43710
W3	0°C	+2300°C	100°C	ASTM E988-90
W5	0°C	+2300°C	100°C	ASTM E988-90
LR	-200°C	+800°C	50°C	GOST 3044-84

Max. Nullpunktverschiebung (Offset) ..... 50% des gewählten Maximalwertes

Vergleichstellenkompensation (CJC)..... < ±1,0°C

Fühlerfehlererkennung..... ja

Fühlerfehlerstrom:

Bei Erkennung ..... Nom. 33 µA

Sonst ..... 0 µA

**Spannungseingang:**

Messbereich ..... -12...800 mV

Min. Messbereich (Spanne) ..... 5 mV

Max. Nullpunktverschiebung (Offset) ..... 50% des gewählten Maximalwertes

Eingangswiderstand ..... 10 MΩ

**Ausgang:****Stromausgang:**

Signalbereich ..... 4...20 mA

Min. Signalbereich ..... 16 mA

Aktualisierungszeit ..... 440 ms

Ausgangssignal bei EEpromfehler ..... ≤ 3,5 mA

Belastungswiderstand ..... ≤ (U<sub>Versorg.</sub> - 7,2) / 0,023 [Ω]

Belastungsstabilität ..... < ±0,01% d. Messsp. / 100 Ω

**Sensorfehlanzeige:**

Programmierbar ..... 3,5...23 mA

NAMUR NE43 aufsteuernd ..... 23 mA

NAMUR NE43 zusteuend ..... 3,5 mA

**d. Messspanne** = der gewählten Messspanne



**Zulassungen:**

EMV .....	2004/108/EG
CCOE.....	P337392/1
EAC .....	TR-CU 020/2011

**Marine-Zulassung:**

Det Norske Veritas, Ships & Offshore ..... Stand. f. Certific. No. 2.4

**Ex / I.S.:**

## ATEX 94/9/EG

5331A.....	KEMA 10ATEX0002 X
5331D.....	KEMA 06ATEX0062 X
FM-Zertifikat.....	2D5A7
CSA-Zertifikat.....	1125003
IECEX.....	DEK 13.0035X
INMETRO.....	DEKRA 13.0001 X
CCOE.....	P337392/2
EAC Ex TR-CU 012/2011 .....	RU C-DK.GB08.V.00410

# ANSCHLÜSSE

## Eingang:

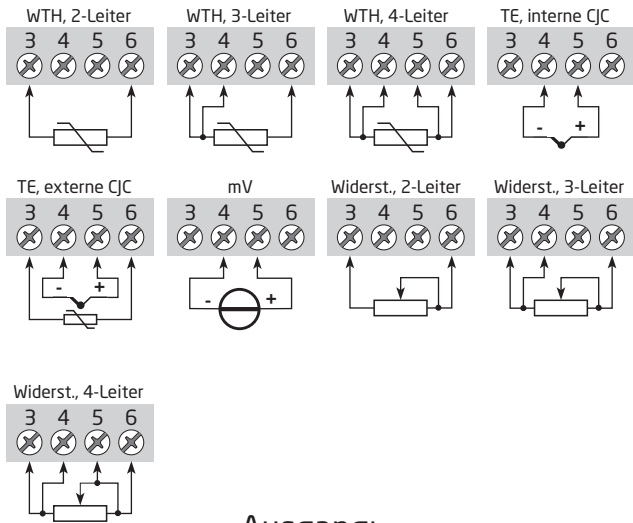

## Ausgang:

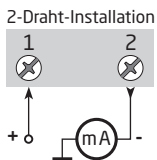

# BLOCKDIAGRAMM

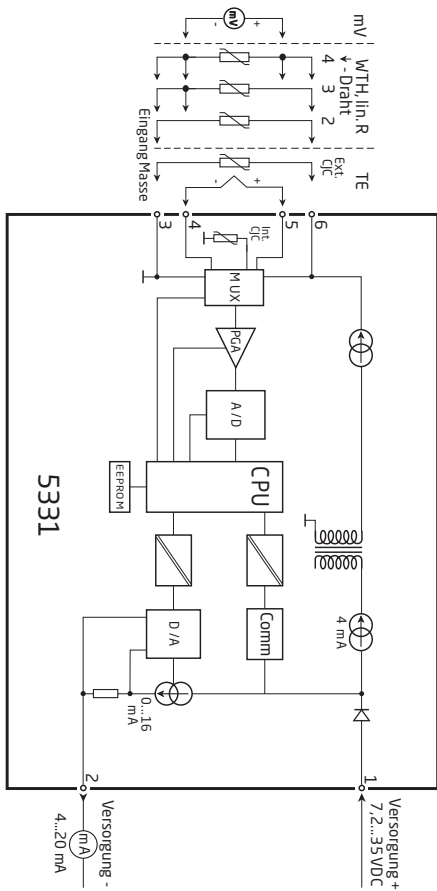

# PROGRAMMIERUNG

- Loop Link ist eine batteriegespeiste Schnittstelle zur Programmierung des 5331.
- Bezüglich Programmierung verweisen wir auf die nachfolgende Zeichnung und die "Hilfe"-Funktion im PReset-Programm.
- Loop Link darf nicht zur Kommunikation mit Modulen, die in Ex-gefährdeten Bereichen installiert sind, benutzt werden.

## Bestellangabe: Loop Link

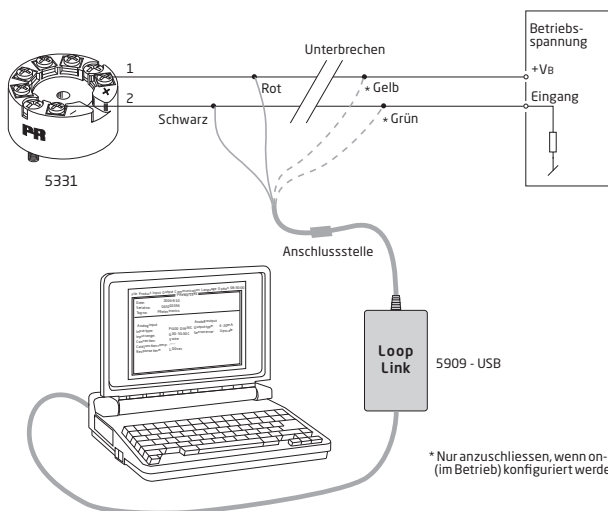

## Abmessungen

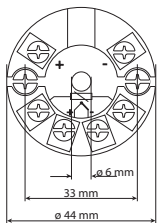

## Montage von Fühlerleitungen

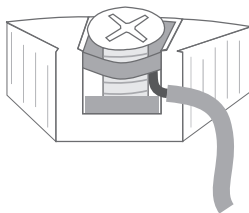
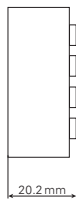

Die Leitungen müssen zwischen den Metalplatten

# APPENDIX

**ATEX Installation Drawing - 5331A**

**ATEX Installation Drawing - 5331D**

**IECEx installation drawing - 5331A**

**IECEx installation drawing - 5331D**

**FM Installation Drawing - 5331D**

**CSA Installation Drawing - 5331D**

**INMETRO Instruções de Segurança - 5331A**

**INMETRO Instruções de Segurança - 5331D**

## ATEX Installationszeichnung

Für die sichere Installation von 5331A3B oder 5334A3B ist Folgendes zu beachten: Das Gerät darf nur von qualifiziertem Personal eingebaut werden, das mit den nationalen und internationalen Gesetzen, Richtlinien und Standards auf diesem Gebiet vertraut ist. Das Baujahr kann aus den ersten beiden Ziffern der Seriennummer ersehen werden.

ATEX-Zertifikat KEMA 10ATEX 0002 X

Markierung  II 3 G Ex nA [ic] IIC T4 ... T6 Gc  
II 3 G Ex ic IIC T4...T6 Gc  
II 3 D Ex ic IIIC Dc

Richtlinien EN 60079-0 : 2012, EN 60079-11 : 2012, EN 60079-15 : 2010

T4: $-40 \leq T_a \leq 85^\circ\text{C}$	<b>Klemme: 3,4,5,6</b>	<b>Klemme: 1,2</b>	<b>Klemme: 1,2</b>
T6: $-40 \leq T_a \leq 60^\circ\text{C}$	Ex nA [ic]	Ex nA	Ex ic
	Uo: 9,6 V	Umax. $\leq 35$ VDC	Ui = 35 VDC
	Io: 25 mA		Ii = 110 mA
	Po: 60 mW		Li = 10 $\mu\text{H}$
	Lo: 33 mH		Ci = 1,0 nF
	Co: 2,4 $\mu\text{F}$		

### Sonderbedingungen für sichere Anwendung:

Für Zündschutzart Ex nA muss der Messumformer in einem Gehäuse, welcher einen Schutzgrad von mindestens IP 54 gemäß EN 60529 besitzt, eingebaut werden.

Für Anwendung in die Präsenz von entflammaren Staub, muss der Messumformer in einem Gehäuse, welcher einen Schutzgrad von mindestens IP 6X gemäß EN 60529 besitzt, eingebaut werden. Die Oberflächentemperatur des Gehäuses ist 20 K über der Umgebungstemperatur.

Bei einer Umgebungstemperatur  $\geq 60^\circ\text{C}$  müssen hitzebeständige Leitungen eingesetzt werden, welche für eine mindestens 20 K höhere Umgebungstemperatur zugelassen sind.

## ATEX Installationszeichnung



Für die sichere Installation von 5331D oder 5334B ist Folgendes zu beachten: Das Gerät darf nur von qualifiziertem Personal eingebaut werden, das mit den nationalen und internationalen Gesetzen, Richtlinien und Standards auf diesem Gebiet vertraut ist. Das Baujahr kann aus den ersten beiden Ziffern der Seriennummer ersehen werden.

ATEX-Zertifikat KEMA 06ATEX 0062 X

Markierung  II 1 G Ex ia IIC T4...T6 Ga  
II 1 D Ex ia IIIC Da  
I M1 Ex ia I Ma

Richtlinien EN 60079-0 : 2012, EN 60079-11 : 2012, EN 60079-26 : 2007,  
EN 60079-15 :2010

Ex-Bereich  
Zone 0, 1, 2, 20, 21, 22

T4:  $-40 \leq T_a \leq 85^\circ\text{C}$   
T6:  $-40 \leq T_a \leq 60^\circ\text{C}$

**Klemme: 3,4,5,6**  
U<sub>o</sub>: 9,6 VDC  
I<sub>o</sub>: 25 mA  
P<sub>o</sub>: 60 mW  
L<sub>o</sub>: 33 mH  
C<sub>o</sub>: 2,4µF

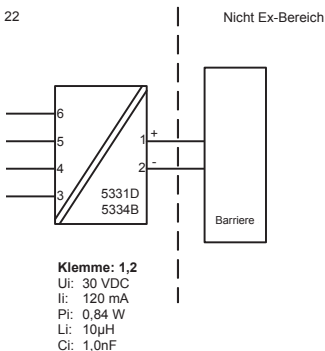



**Installationsvorschriften**

Die galvanische Trennung zwischen dem Sensorkreis und dem Eingangskreis ist nicht unfehlbar. Allerdings ist die galvanische Trennung zwischen den Kreisen so ausgelegt, dass diese eine Testspannung von 500 VAC für eine Minute aushält.

Für Anwendung in einer potentiellen explosiven Atmosphäre - basierend auf entflammbares Gas - muss der Messumformer in einem Gehäuse, welcher einen Schutzgrad von mindestens IP20 gemäß EN 60529 besitzt, eingebaut werden.

Für Applikationen in explosiver Atmosphäre, wo Kategorie 1 G, 1 M oder 2 M Geräte vorgeschrieben sind, und wenn das Gehäuse aus Aluminium ist, ist das Gehäuse so zu montieren, dass Zündquellen (Stöße und Reibungsfunken) selbst bei selten auftretenden Störungen vermieden werden; wenn das Gehäuse aus nichtmetallischen Bestandteile ist, muss die elektrostatische Ladung der Gehäuse vermieden werden.

Für Anwendung in einer potentiellen explosiven Atmosphäre - basierend auf entflammbaren Staub - ist Folgendes zu beachten:

Der Messumformer muss in einem Metallkopf Form B gemäß DIN 43729 montiert werden. Das Gehäuse muss einen Schutzgrad von mindestens IP 6X gemäß EN 60529 besitzen und für den dementsprechenden Einsatz zugelassen werden.

Es dürfen nur Kabeleinführungen und Abdeckungen eingesetzt werden, welche für die jeweilige Anwendung zugelassen sind.

Bei einer Umgebungstemperatur  $\geq 60^{\circ}\text{C}$  müssen hitzebeständige Leitungen eingesetzt werden, welche für eine mindestens 20 K höhere Umgebungstemperatur zugelassen sind.

Die Umgebungstemperatur der Gehäuse entspricht der Umgebungstemperatur plus 20K für eine Staubschicht mit einer Dicke von bis zu 5 mm.

## IECEx Installation drawing



For safe installation of 5331A or 5334A the following must be observed. The module shall only be installed by qualified personnel who are familiar with the national and international laws, directives and standards that apply to this area.  
Year of manufacture can be taken from the first two digits in the serial number.

Certificate	IECEx DEK 13.0035X
Marking	Ex nA [ic] IIC T4..T6 Gc Ex ic IIC T4..T6 Gc Ex ic IIIC Dc
Standards	IEC 60079-0 : 2011, IEC 60079-11 : 2011, IEC 60079-15 : 2010

T4: $-40 \leq T_a \leq 85^\circ\text{C}$	<b>Terminal: 3,4,5,6</b>	<b>Terminal: 1,2</b>	<b>Terminal: 1,2</b>
T6: $-40 \leq T_a \leq 60^\circ\text{C}$	Uo: 9.6 V	Ex nA	Ex ic
	Io: 25 mA		
	Po: 60 mW	Umax =35 VDC	Ui = 35 VDC
	Lo: 33 mH		Ii = 110mA
	Co: 2.4 $\mu\text{F}$		Li = 10 $\mu\text{H}$
			Ci = 1.0 nF

### Installation note:

For installation in a potentially explosive gas atmosphere, the following instructions apply:  
For nA installation the transmitter must be installed in a metal enclosure, e.g. a form B enclosure providing a degree of protection of at least IP54 according to IEC60529 or in an enclosure with type of protection Ex n or Ex e.

For ic installation the transmitter must be installed in enclosure providing a degree of protection of at least IP20 according to IEC60529 and that is suitable for the application.

Cable entry devices and blanking elements shall fulfill the same requirements  
For an ambient temperature  $\geq 60^\circ\text{C}$ , heat resistant cables shall be used with a rating of at least 20 K above the ambient temperature.

For installation in a potentially explosive dust atmosphere, the following instructions apply:  
The surface temperature of the enclosure is equal to the ambient temperature plus 20 K, for a dust layer with a thickness up to 5 mm.  
The transmitter must be mounted in a enclosure according to DIN 43729 that provides a degree of protection of at least IP6X according to IEC60529, and that is suitable for the application. Cable entry devices and blanking elements shall fulfill the same requirements.

## IECEx Installation drawing



For safe installation of 5331D or 5334B the following must be observed. The module shall only be installed by qualified personnel who are familiar with the national and international laws, directives and standards that apply to this area.

Year of manufacture can be taken from the first two digits in the serial number.

Certificate	IECEx DEK 13.0035X
Marking	Ex ia IIC T4...T6 Ga Ex ia IIIC Da Ex ia I Ma
Standards	IEC 60079-0 : 2011, IEC 60079-11 : 2011, IEC 60079-26:2006

### Hazardous area

Zone 0, 1, 2, 20, 21, 22, M1

T4:  $-40 \leq T_a \leq 85^\circ\text{C}$

T5:  $-40 \leq T_a \leq 60^\circ\text{C}$

T6:  $-40 \leq T_a \leq 45^\circ\text{C}$

### Terminal: 3,4,5,6

U<sub>o</sub>: 9.6 VDC

I<sub>o</sub>: 25 mA

P<sub>o</sub>: 60 mW

L<sub>o</sub>: 33 mH

C<sub>o</sub>: 2.4  $\mu\text{F}$

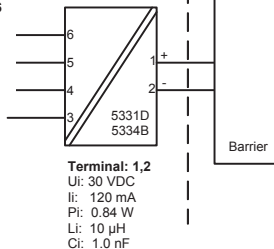

**Installation notes.**

The sensor circuit is not infallibly galvanic isolated from the input circuit. However, the galvanic isolation between the circuits is capable of withstanding a test voltage of 500Vac during 1 minute.

In a potentially explosive gas atmosphere, the transmitter shall be mounted in a metal form B enclosure in order to provide a degree of protection of at least IP20 according to IEC60529. If however the environment requires a higher degree of protection, this shall be taken into account.

If the transmitter is installed in an explosive atmosphere requiring the use of equipment protection level Ga, Ma and Mb, and if the enclosure is made of aluminum, it must be installed such, that ignition sources due to impact and friction sparks are excluded.

For installation in a potentially explosive dust atmosphere, the following instructions apply:

For explosive dust atmospheres, the surface temperature of the outer enclosure is 20 K above the ambient temperature.

The transmitter shall be mounted in a metal enclosure form B according to DIN43729 that is providing a degree of protection of at least IP6X according to IEC60529, that is suitable for the application and correctly installed.

Cable entries and blanking elements shall be used that are suitable for the application and correctly installed.

For an ambient temperature  $\geq 60^{\circ}\text{C}$ , heat resistant cables shall be used with a rating of at least 20 K above the ambient temperature.

## FM Installation Drawing 5300Q502 Rev AH

### Model 5331C, 5331D, 5333C, 5333D and 5343B

#### Hazardous (Classified) Location

Class I, Division 1, Groups, A, B, C, D T4..T6  
Class I, Zone 0, AEx ia IIC T4..T6

Ambient temperature limits  
T4: -40 to +85 deg. Celsius  
T6: -40 to +60 deg. Celsius

Terminal 1, 2  
Vmax or Ui: 30 V  
Imax or Ii: 120 mA  
Pmax or Pi: 0.84 W  
Ci: 1 nF  
Li: 10 uH

Terminal 3,4,5,6  
Vt or Uo: 9.6 V  
It or Io: 28 mA  
Pt or Po: 67.2 mW  
Ca or Co: 3.5 uF  
La or Lo: 35 mH

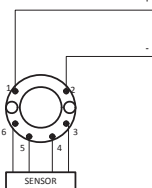

#### Non Hazardous Location

Associated Apparatus  
or Barrier  
with  
entity Parameters:

$UM \leq 250V$   
 $Voc \text{ or } Uo \leq Vmax \text{ or } Ui$   
 $Isc \text{ or } Io \leq Imax \text{ or } Ii$   
 $Po \leq Pi$   
 $Ca \text{ or } Co \geq Ci + Ccable$   
 $La \text{ or } Lo \geq Li + Lcable$

This device must not be connected  
to any associated apparatus which  
uses or generates more than 250  
Vrms

### Model 5335C, 5335D, 5336D, 5337D

#### Hazardous (Classified) Location

Class I, Division 1, Groups, A, B, C, D T4..T6  
Class I, Zone 0, AEx ia IIC T4..T6

Ambient temperature limits  
T4: -40 to +85 deg. Celsius  
T6: -40 to +60 deg. Celsius

Terminal 1, 2  
Vmax or Ui: 30 V  
Imax or Ii: 120 mA  
Pmax or Pi: 0.84 W  
Ci: 1 nF  
Li: 10 uH

Terminal 3,4,5,6  
Vt or Uo: 9.6 V  
It or Io: 28 mA  
Pt or Po: 67.2 mW  
Ca or Co: 3.5 uF  
La or Lo: 35 mH

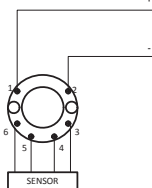

#### Non Hazardous Location

Associated Apparatus  
or Barrier  
with  
entity Parameters:

$UM \leq 250V$   
 $Voc \text{ or } Uo \leq Vmax \text{ or } Ui$   
 $Isc \text{ or } Io \leq Imax \text{ or } Ii$   
 $Po \leq Pi$   
 $Ca \text{ or } Co \geq Ci + Ccable$   
 $La \text{ or } Lo \geq Li + Lcable$

This device must not be connected  
to any associated apparatus which  
uses or generates more than 250  
Vrms

### The entity concept

The Transmitter must be installed according to National Electrical Code (ANSI-NFPA 70) and shall be installed with the enclosure, mounting, and spacing segregation requirement of the ultimate application.

Equipment that is FM-approved for intrinsic safety may be connected to barriers based on the ENTITY CONCEPT. This concept permits interconnection of approved transmitters, meters and other devices in combinations which have not been specifically examined by FM, provided that the agency's criteria are met. The combination is then intrinsically safe, if the entity concept is acceptable to the authority having jurisdiction over the installation.

The entity concept criteria are as follows:

The intrinsically safe devices, other than barriers, must not be a source of power.

The maximum voltage  $U_i(V_{MAX})$  and current  $I_i(I_{MAX})$ , and maximum power  $P_i(P_{MAX})$ , which the device can receive and remain intrinsically safe, must be equal to or greater than the voltage ( $U_o$  or  $V_{OC}$  or  $V_i$ ) and current ( $I_o$  or  $I_{SC}$  or  $I_i$ ) and the power  $P_o$  which can be delivered by the barrier.

The sum of the maximum unprotected capacitance ( $C_i$ ) for each intrinsically device and the interconnecting wiring must be less than the capacitance ( $C_a$ ) which can be safely connected to the barrier.

The sum of the maximum unprotected inductance ( $L_i$ ) for each intrinsically device and the interconnecting wiring must be less than the inductance ( $L_a$ ) which can be safely connected to the barrier.

The entity parameters  $U_o, V_{OC}$  or  $V_i$  and  $I_o, I_{SC}$  or  $I_i$ , and  $C_a$  and  $L_a$  for barriers are provided by the barrier manufacturer.

### NI Field Circuit Parameters

## Model 5331C, 5331D, 5333C, 5333D, 5335C, 5335D, 5336D, 5337D and 5343B

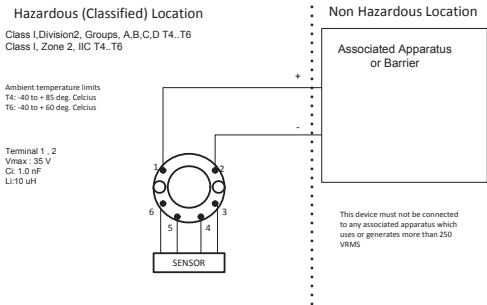

## CSA Installation drawing 533XQC03

Hazardous area

T4:  $-40 \leq T_a \leq 85^\circ\text{C}$

T6:  $-40 \leq T_a \leq 60^\circ\text{C}$

Module 5331D, 5333D

**Terminal: 3,4,5,6**

Only passive, or non-energy storing devices such as RTD's and Thermocouples may be connected

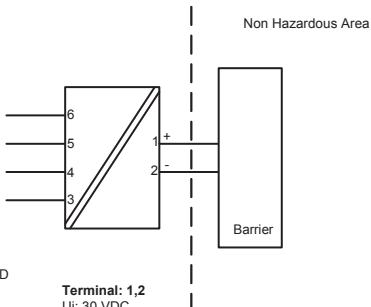

Module 5335D, 5336D and 5337D

**Terminal: 3,4,5,6**

Uo: 9.6 VDC

Io: 28 mA

Po: 67.2 mW

Lo: 35 mH

Co: 2.5  $\mu\text{F}$

**Terminal: 1,2**

Ui: 30 VDC

Ii: 120 mA

Pi: 0.84 W

Li: 10  $\mu\text{H}$

Ci: 1.0 nF

CLASS 2258 04 - PROCESS CONTROL EQUIPMENT - Intrinsically Safe Entity - For Hazardous Locations

Class I, Division 1, Groups A, B, C and D

Ex ia IIC, Ga

CLASS 2258 84 - PROCESS CONTROL EQUIPMENT - Intrinsically Safe Entity - For Hazardous Locations - Certified to US Standards

Class I, Division 1, Groups A, B, C and D

Class I, Zone 0, AEx ia IIC, Ga

### Warning:

Substitution of components may impair intrinsic safety.

The transmitters must be installed in a suitable enclosure to meet installation codes stipulated in the Canadian Electrical Code (CEC) or for US the National Electrical Code (NEC).

## Desenho de Instalação INMETRO



Para instalação segura do 5331A ou 5334A o seguinte deve ser observado. O modo deve apenas ser instalado por pessoas qualificadas que são familiarizadas com as leis nacionais e internacionais, diretrizes e padrões que se aplicam a esta área.

Ano de fabricação pode ser pego dos dois primeiros dígitos do número de série.

Certificado	DEKRA 13.0001 X
Indicação	Ex nA [ic] IIC T4..T6 Gc Ex ic IIC T4..T6 Gc Ex ic IIIC Dc

Padrões ABNT NBR IEC 60079-0 : 2008, ABNT NBR IEC 60079-11 : 2009,  
IEC 60079-15 : 2010, ABNT NBR IEC 60079-26 : 2008

T4: $-40 \leq T_a \leq 85^\circ\text{C}$	<b>Terminal: 3,4,5,6</b>	<b>Terminal: 1,2</b>	<b>Terminal: 1,2</b>
T6: $-40 \leq T_a \leq 60^\circ\text{C}$	Uo: 9,6 V	Ex nA	Ex ic
	Io: 25 mA		
	Po: 60 mW	Umax =35 VDC	Ui = 35 VDC
	Lo: 33 mH		Ii = 110 mA
	Co: 2,4 $\mu\text{F}$		Li = 10 $\mu\text{H}$
			Ci = 1,0 nF

### Notas para instalação

Para a instalação em uma atmosfera de gás potencialmente explosivo, se aplicam as instruções a seguir:

Para a instalação nA o transmissor deve ser instalado em um gabinete de metal, por exemplo, gabinete em forma B que forneça um grau de proteção de pelo menos IP54 de acordo com IEC60529 ou em um caixa com tipo de proteção Ex n ou Ex e.

Para a instalação IC o transmissor deve ser instalado em um invólucro proporcionando um grau de proteção de IP20, pelo menos, de acordo com a norma IEC60529 que é adequado para a aplicação.

Dispositivos de entrada de cabos e elementos de supressão devem cumprir os mesmos requisitos.

Para uma temperatura ambiente  $\geq 60^\circ\text{C}$ , os cabos resistentes ao calor precisam ser utilizados com uma classificação de pelo menos 20 K acima da temperatura ambiente.

Para a instalação em uma atmosfera de poeira potencialmente explosiva, se aplicam as instruções a seguir:

A temperatura da superfície do invólucro é igual à temperatura ambiente mais 20 K, para uma camada de pó, com uma espessura superior a 5 mm.

O transmissor deve ser montado em um invólucro de acordo com a norma DIN 43729, que proporciona um grau de proteção de, pelo menos, IP6X de acordo com a norma IEC60529, e que seja apropriado para a aplicação.

Dispositivos de entrada de cabos e elementos de supressão devem cumprir as mesmas exigências.



## Desenho de Instalação INMETRO



Para instalação segura do 5331D ou 5334B o seguinte deve ser observado. O modo deve apenas ser instalado por pessoas qualificadas que são familiarizadas com as leis nacionais e internacionais, diretrizes e padrões que se aplicam a esta área.  
Ano de fabricação pode ser pego dos dois primeiros dígitos do número de série.

Certificado .....DEKRA 13.0001 X

Indicação Ex ia IIC T6...T4 Ga  
Ex ia IIIC Da

Padrões ABNT NBR IEC 60079-0 : 2008 ABNT NBR IEC 60079-11 : 2009 IEC 60079-15 : 2010  
ABNT NBR IEC 60079-26 : 2008

### Áreas Perigosas

Zona 0, 1, 2, 20, 21, 22,

T4:  $-40 \leq T_a \leq 85^\circ\text{C}$

T5:  $-40 \leq T_a \leq 60^\circ\text{C}$

T6:  $-40 \leq T_a \leq 45^\circ\text{C}$

### Terminal: 3,4,5,6

Uo: 9,6 VDC

Io: 25 mA

Po: 60 mW

Lo: 33 mH

Co: 2,4 $\mu\text{F}$

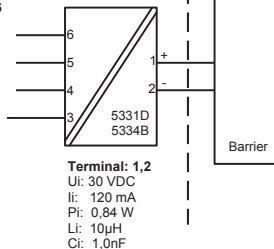

**Notas de instalação**

O circuito do sensor não é isolado galvanicamente infalível do circuito de entrada. Contudo, a isolação galvânica entre os circuitos é capaz de resistir a um teste de tensão de 500Vac durante 1 minuto.

Em uma atmosfera de gás potencialmente explosiva, o transmissor deve ser montado em um enclosure a fim de garantir um grau de proteção de no mínimo IP20 de acordo com EN60529. Se contudo o ambiente requer um nível de proteção maior, isso deve ser levado em conta

Se o transmissor é instalado em uma atmosfera explosiva exigindo o uso de equipamento de categoria Ga e se o enclosure é feito de alumínio, ele deve ser instalado de modo que, mesmo em caso de avaria rara, fontes de ignição devido a impacto e fricção, faíscas são eliminadas; se o enclosure é feito de materiais não metálicos, cargas eletroestáticas devem ser evitadas.

Para instalação em atmosfera de poeira potencialmente explosiva, as instruções a seguir:

O transmissor deve ser montado em enclosure de metal forma B de acordo com DIN43729 que está fornecendo um grau de proteção de pelo menos IP6X de acordo com EN60529. Isso é adequado para aplicação e corretamente instalado.

As entradas dos cabos e os elementos de obturação que podem ser utilizados são adequados para a aplicação e corretamente instalados.

Para temperatura ambiente  $\geq 60^{\circ}\text{C}$ , fios de resistência ao calor devem ser usados com uma faixa de pelo menos 20K acima da temperatura ambiente.

A temperatura da superfície do enclosure é igual à temperatura ambiente mais de 20 K, por uma camada de pó, com uma espessura até 5 mm.



**Displays** Programmable displays with a wide selection of inputs and outputs for display of temperature, volume and weight, etc. Feature linearization, scaling, and difference measurement functions for programming via PReset software.



**Ex interfaces** Interfaces for analog and digital signals as well as HART signals between sensors / I/P converters / frequency signals and control systems in Ex zone 0, 1 & 2 and for some devices in zone 20, 21 & 22.



**Isolation** Galvanic isolators for analog and digital signals as well as HART signals. A wide product range with both loop-powered and universal isolators featuring linearization, inversion, and scaling of output signals.





























**Temperature** A wide selection of transmitters for DIN form B mounting and DIN rail devices with analog and digital bus communication ranging from application-specific to universal transmitters.



**Universal** PC or front programmable devices with universal options for input, output and supply. This range offers a number of advanced features such as process calibration, linearization and auto-diagnosis.



-   [www.preelectronics.fr](http://www.preelectronics.fr)  
 [sales-fr@preelectronics.com](mailto:sales-fr@preelectronics.com)
-   [www.preelectronics.de](http://www.preelectronics.de)  
 [sales-de@preelectronics.com](mailto:sales-de@preelectronics.com)
-   [www.preelectronics.es](http://www.preelectronics.es)  
 [sales-es@preelectronics.com](mailto:sales-es@preelectronics.com)
-   [www.preelectronics.it](http://www.preelectronics.it)  
 [sales-it@preelectronics.com](mailto:sales-it@preelectronics.com)
-   [www.preelectronics.se](http://www.preelectronics.se)  
 [sales-se@preelectronics.com](mailto:sales-se@preelectronics.com)
-   [www.preelectronics.com](http://www.preelectronics.com)  
 [sales-uk@preelectronics.com](mailto:sales-uk@preelectronics.com)
-   [www.preelectronics.com](http://www.preelectronics.com)  
 [sales-us@preelectronics.com](mailto:sales-us@preelectronics.com)
-   [www.preelectronics.cn](http://www.preelectronics.cn)  
 [sales-cn@preelectronics.com](mailto:sales-cn@preelectronics.com)
-   [www.preelectronics.be](http://www.preelectronics.be)  
 [sales-be@preelectronics.com](mailto:sales-be@preelectronics.com)

## Head office

Denmark  
PR electronics A/S  
Lerbakken 10  
DK-8410 Rønde

[www.preelectronics.com](http://www.preelectronics.com)  
[sales@preelectronics.dk](mailto:sales@preelectronics.dk)  
tel. +45 86 37 26 77  
fax +45 86 37 30 85



QUALITY SYSTEM AND ENVIRONMENTAL MANAGEMENT SYSTEM  
DS/EN ISO 9001  
DS/EN ISO 14001

